

Dell™ Latitude™ ATG D620 Service Manual

[Before You Begin](#)
[Media Bay Devices](#)

[Hard Drive](#)
[Hinge Cover](#)

[Keyboard](#)
[Memory](#)

[Display Assembly](#)

[Internal Card With Bluetooth® Wireless Technology](#)

[Communications Cards](#)

[Coin-Cell Battery](#)

[Palm Rest](#)

[Modem](#)

[Processor Thermal-Cooling Assembly](#)

[Processor](#)

[Speaker](#)

[PC Card Reader](#)



[System Board](#)

[Fan](#)

[Base](#)

[Flashing the BIOS](#)

Notes, Notices, and Cautions

-  **NOTE:** A NOTE indicates important information that helps you make better use of your computer.
-  **NOTICE:** A NOTICE indicates either potential damage to hardware or loss of data and tells you how to avoid the problem.
-  **CAUTION:** A CAUTION indicates a potential for property damage, personal injury, or death.

Information in this document is subject to change without notice.
© 2007 Dell Inc. All rights reserved.

Reproduction in any manner whatsoever without the written permission of Dell Inc. is strictly forbidden.

Trademarks used in this text: *Dell*, the *DELL* logo, and *Latitude* are trademarks of Dell Inc.; *Microsoft* and *Windows* are registered trademarks of Microsoft Corporation; *Bluetooth* is a registered trademark owned by Bluetooth SIG, Inc. and is used by Dell under license.

Other trademarks and trade names may be used in this document to refer to either the entities claiming the marks and names or their products. Dell Inc. disclaims any proprietary interest in trademarks and trade names other than its own.



Model PP18L

January 2007 Rev. A00

[Back to Contents Page](#)

Base

Dell™ Latitude™ ATG D620 Service Manual

-  **CAUTION:** Before working inside your computer, follow the safety instructions in the *Product Information Guide*.
-  **CAUTION:** To prevent static damage to components inside your computer, discharge static electricity from your body before you touch any of your computer's electronic components. You can do so by touching an unpainted metal surface.

1. Follow the instructions in [Before You Begin](#).
2. Remove the system board (see [System Board](#)).
3. Remove the fan (see [Fan](#)).

 **NOTE:** If the base has the improved K-Lock, the K-Lock is held down with a screw. Remove and discard the screw when installing this base, as the screw is not needed.

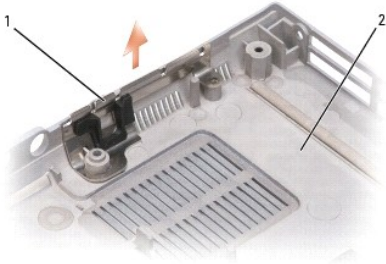

1	K-Lock assembly	2	base
---	-----------------	---	------

[Back to Contents Page](#)

Before You Begin

Dell™ Latitude™ ATG D620 Service Manual

- [Recommended Tools](#)
- [Turning Off Your Computer](#)
- [Before Working Inside Your Computer](#)

This document provides procedures for removing and installing the components in your computer. Unless otherwise noted, each procedure assumes the following:

- 1 You have performed the steps in [Turning Off Your Computer](#) and [Before Working Inside Your Computer](#).
- 1 You have read the safety information in the *Product Information Guide*.
- 1 A component can be replaced by performing the removal procedure in reverse order.

Recommended Tools

The procedures in this document may require the following tools:

- 1 Small flat-blade screwdriver
- 1 Phillips screwdriver
- 1 Small plastic scribe
- 1 5-mm hex nut driver
- 1 Flash BIOS-update program CD
- 1 Processor extraction tool

Turning Off Your Computer

➡ **NOTICE:** To avoid losing data, save and close any open files and exit any open programs before you turn off your computer.

1. Shut down the operating system:
 - a. Save and close any open files and exit any open programs
 - b. Click **Start**→**Shut Down**→**Shut down**.

The computer turns off after the operating system shutdown process finishes.

2. Ensure that the computer and any attached devices are turned off. If your computer and attached devices do not automatically turn off when you shut down your operating system, press and hold the power button for 4 seconds.

Before Working Inside Your Computer

Use the following safety guidelines to help protect your computer from potential damage and to help ensure your own personal safety.

⚠ **CAUTION:** Before you begin any of the procedures in this section, follow the safety instructions in the *Product Information Guide*.

⚠ **CAUTION:** Handle components and cards with care. Do not touch the components or contacts on a card. Hold a card by its edges or by its metal mounting bracket. Hold a component such as a processor by its edges, not by its pins.

➡ **NOTICE:** Only a certified service technician should perform repairs on your computer. Damage due to servicing that is not authorized by Dell is not covered by your warranty.

➡ **NOTICE:** When you disconnect a cable, pull on its connector or on its pull-tab, not on the cable itself. Some cables have a connector with locking tabs; if you are disconnecting this type of cable, press in on the locking tabs before you disconnect the cable. As you pull connectors apart, keep them evenly aligned to avoid bending any connector pins. Also, before you connect a cable, ensure that both connectors are correctly oriented and aligned.

➡ **NOTICE:** To avoid damaging the computer, perform the following steps before you begin working inside the computer.

1. Ensure that the work surface is flat and clean to prevent the computer cover from being scratched.
2. Turn off your computer (see [Turning Off Your Computer](#)).

➡ **NOTICE:** To disconnect a network cable, first unplug the cable from your computer and then unplug it from the network device.

3. Disconnect any telephone, network, and USB cables from the computer.
4. Disconnect your computer and all attached devices from their electrical outlets.
5. Turn over the computer.

➡ **NOTICE:** To avoid damaging the system board, you must remove the main battery before you service the computer.

6. Remove the battery:
 - a. Slide the two battery-bay latch releases on the bottom of the computer toward the sides of the computer until they are engaged.
 - b. Grasp the battery by the battery tab and slide the battery horizontally toward the front of the computer.
 - c. Lift to remove the battery from the bay.

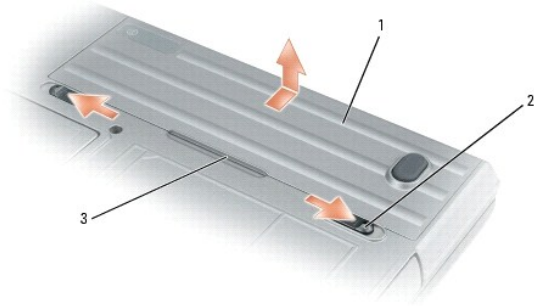

1	battery	2	battery-bay latch releases (2)	3	battery tab
---	---------	---	--------------------------------	---	-------------

7. Press the power button to ground the system board.
8. Remove any PC Card or ExpressCard, if installed, from the PC Card slot.

[Back to Contents Page](#)

Flashing the BIOS

Dell™ Latitude™ ATG D620 Service Manual

- [Flashing the BIOS From a CD](#)
- [Flashing the BIOS From the Hard Drive](#)

If a BIOS-update program CD is provided with the new system board, flash the BIOS from the CD. If you do not have a BIOS-update program CD, flash the BIOS from the hard drive.

Flashing the BIOS From a CD

1. Ensure that the AC adapter is plugged in and that the main battery is installed properly.

 **NOTE:** If you use a BIOS-update program CD to flash the BIOS, set up the computer to boot from a CD before inserting the CD.

2. Insert the BIOS-update program CD, and restart the computer.

Follow the instructions that appear on the screen. The computer continues to boot and updates the new BIOS. When the flash update is complete, the computer will automatically reboot.

3. Press <F2> during POST to enter the system setup program.
 4. Press <Alt> and <F> to reset the computer defaults.
 5. Press <Esc>, select **Save changes and reboot**, and press <Enter> to save configuration changes.
 6. Remove the flash BIOS-update program CD from the drive and restart the computer.
-

Flashing the BIOS From the Hard Drive

1. Ensure that the AC adapter is plugged in, the main battery is properly installed, and a network cable is attached.
 2. Turn on the computer.
 3. Locate the latest BIOS update file for your computer at support.dell.com.
 4. Click **Download Now** to download the file.
 5. If the **Export Compliance Disclaimer** window appears, click **Yes, I Accept this Agreement**.
The **File Download** window appears.
 6. Click **Save this program to disk** and then click **OK**.
The **Save In** window appears.
 7. Click the down arrow to view the **Save In** menu, select **Desktop**, and then click **Save**.
The file downloads to your desktop.
 8. Click **Close** if the **Download Complete** window appears.
The file icon appears on your desktop and is titled the same as the downloaded BIOS update file.
 9. Double-click the file icon on the desktop and follow the instructions on the screen.
-

Internal Card With Bluetooth® Wireless Technology

Dell™ Latitude™ ATG D620 Service Manual

⚠ CAUTION: Before working inside your computer, follow the safety instructions in your *Product Information Guide*.

➡ NOTICE: To avoid electrostatic discharge, ground yourself by using a wrist grounding strap or by periodically touching a connector on the back panel of the computer.

➡ NOTICE: To avoid damaging the system board, you must remove the main battery before you begin working inside the computer (see [Before Working Inside Your Computer](#)).

If you ordered an internal card with Bluetooth wireless technology with your computer, it is already installed.

1. Follow the procedures in [Before You Begin](#).

2. Remove the hinge cover (see [Hinge Cover](#)).

➡ NOTICE: Be careful when removing the card to avoid damaging the card, card cable, or surrounding components.

3. Carefully remove the card cable from its routing guide.

4. While grasping the card cable with one hand, gently press slightly downward (with a plastic scribe) on the tiny, plastic securing tab (shown below) to release the cable end of the card.



1	connector wire	2	plastic scribe	3	plastic securing tab
4	metal securing tab	5	plastic securing tab		

5. Continue to grasp the card cable with one hand while gently prying the card out from underneath the metal tab with the other hand.

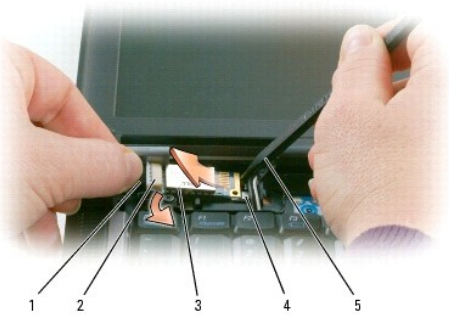

1	cable	2	card connector	3	card
4	metal tab	5	plastic scribe		

6. Lift the card from the compartment, ensuring that you do not pull on the card cable with excessive force.
7. Disconnect the card from the cable and remove the card from the computer.



[Back to Contents Page](#)

Coin-Cell Battery

Dell™ Latitude™ ATG D620 Service Manual

⚠ CAUTION: Before working inside your computer, follow the safety instructions in your *Product Information Guide*.

➡ NOTICE: To avoid electrostatic discharge, ground yourself by using a wrist grounding strap or by periodically touching a connector on the back panel of the computer.

➡ NOTICE: To avoid damaging the system board, you must remove the main battery before you begin working inside the computer.

1. Follow the procedures in [Before You Begin](#).
2. Remove the hinge cover (see [Hinge Cover](#)).
3. Remove the keyboard (see [Keyboard](#)).

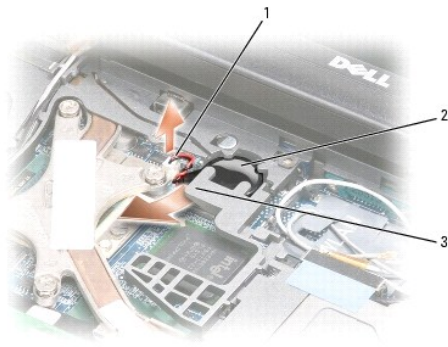

1	battery cable connector	2	coin-cell battery	3	plastic arm
---	-------------------------	---	-------------------	---	-------------

4. Remove the battery cable connector from the connector on the system board.
5. Being careful not to break the plastic, slightly raise the corner of the plastic arm above the battery.
6. While holding the plastic arm slightly up, grasp the battery and pull it out of the battery compartment.

Processor

Dell™ Latitude™ ATG D620 Service Manual

- [Removing the Processor](#)
- [Installing the Processor](#)

Removing the Processor

⚠ CAUTION: Before working inside your computer, follow the safety instructions in the *Product Information Guide*.

⚠ CAUTION: To prevent static damage to components inside your computer, discharge static electricity from your body before you touch any of your computer's electronic components. You can do so by touching an unpainted metal surface.

➡ NOTICE: To prevent intermittent contact between the ZIF-socket cam screw and the processor when removing or replacing the processor, press to apply slight pressure to the center of the processor while turning the cam screw.

➡ NOTICE: To avoid damage to the processor, hold the screwdriver so that it is perpendicular to the processor when turning the cam screw.

1. Follow the instructions in [Before Working Inside Your Computer](#).
2. Remove the hinge cover (see [Hinge Cover](#)).
3. Remove any installed media bay device (see [Media Bay Devices](#)).
4. Remove the keyboard (see [Keyboard](#)).
5. Remove the palm rest (see [Palm Rest](#)).
6. Remove the processor thermal-cooling assembly (see [Processor Thermal-Cooling Assembly](#)).

➡ NOTICE: When removing the processor, pull it straight up. Be careful not to bend the pins on the processor.

7. To loosen the ZIF socket, use a small, flat-blade screwdriver and rotate the ZIF-socket cam screw counterclockwise until it comes to the cam stop.
The ZIF-socket cam screw secures the processor to the system board. Take note of the arrow on the ZIF-socket cam screw.

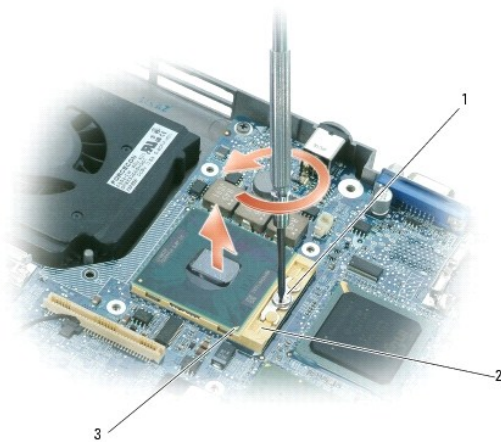

1	ZIF-socket cam screw	2	ZIF-socket	3	pin-1 corner of processor
---	----------------------	---	------------	---	---------------------------

8. Use a processor extraction tool to remove the processor.
-

Installing the Processor

 **NOTICE:** Ensure that the cam lock is in the fully open position before seating the processor. Seating the processor properly in the ZIF socket does not require force.

 **NOTICE:** A processor that is not properly seated can result in an intermittent connection or permanent damage to the processor and ZIF socket.

1. Align the pin-1 corner of the processor so that it points to the triangle on the system board, and insert the processor into the ZIF socket.

When the processor is correctly seated, all four corners are aligned at the same height. If one or more corners of the processor are higher than the others, the processor is not seated correctly.

 **NOTICE:** To prevent intermittent contact between the ZIF-socket cam screw and the processor when removing or replacing the processor, press to apply slight pressure to the center of the processor while turning the cam screw.

2. Tighten the ZIF socket by turning the cam screw clockwise to secure the processor to the system board.
3. Peel the backing off the thermal cooling pad and adhere the pad to the portion of the thermal-cooling assembly that covers the processor.
4. Replace the processor thermal-cooling assembly (see [Processor Thermal-Cooling Assembly](#)).
5. Replace the palm rest (see [Palm Rest](#)).

 **NOTE:** Ensure that you reconnect the coin-cell battery (see [Coin-Cell Battery](#)) before you replace the keyboard.

6. Replace the keyboard (see [Keyboard](#)).
7. Replace the media bay device (see [Media Bay Devices](#)).
8. Replace the hinge cover (see [Hinge Cover](#)).
9. Replace the battery.
10. Update the BIOS using a flash BIOS-update program CD. See [Flashing the BIOS](#).

[Back to Contents Page](#)

Display Assembly

Dell™ Latitude™ ATG D620 Service Manual

- [Removing the Display Assembly](#)
- [Removing the Display Bezel](#)
- [Removing the Display Panel](#)
- [Removing the Display Panel Brackets](#)
- [Removing the Display Panel Cable](#)
- [Removing the Display Hinges](#)

Removing the Display Assembly

⚠ CAUTION: Before working inside your computer, follow the safety instructions in the *Product Information Guide*.

⚠ CAUTION: To prevent static damage to components inside your computer, discharge static electricity from your body before you touch any of your computer's electronic components. You can do so by touching an unpainted metal surface.

1. Follow the instructions in [Before You Begin](#).
2. Remove the hinge cover (see [Hinge Cover](#)).
3. Remove the keyboard (see [Keyboard](#)).

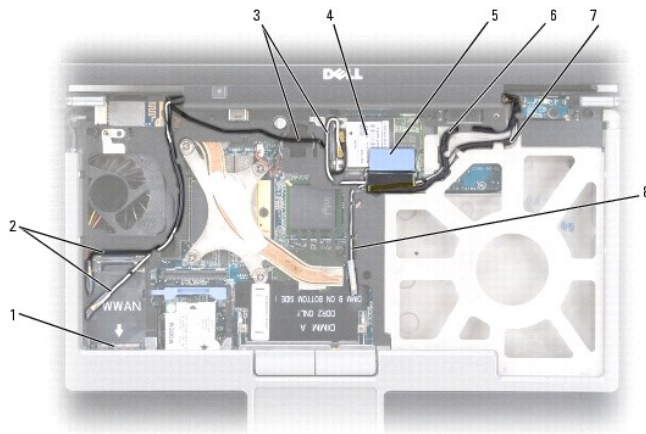

1	WWAN card connector	2	WWAN antenna cables	3	WLAN antenna cables (black and white)
4	WLAN card	5	pull-tab	6	display cable
7	WLAN antenna cables (white and gray)	8	WLAN antenna cable (currently unused) (gray)		

ⓘ NOTICE: To avoid damage to your computer, use the illustration above when replacing the display assembly to carefully reroute the cables in the appropriate cable channels. Route the gray and black antenna cables beneath the white antenna cable, and the black display cable on top of the white antenna cable.

4. Pull straight up on the pull-tab that is attached to the display-feed flex cable to disconnect the cable from the system board.
5. Disconnect the antenna cables from their card(s) (see [Communications Cards](#)).
6. Carefully remove the antenna cables and the display cable from their routing guides.
7. Close the display.
8. Turn the computer upside-down with the back of the computer facing you.

9. From the bottom of the computer, remove the two M2.5 x 8-mm screws labeled "D."



10. From the back of the computer, remove the two M2.5 x 8-mm screws.



11. Turn the computer right-side up and open the display.



1	antenna cables (2)	2	display cable pull-tab
---	--------------------	---	------------------------

12. Lift the display assembly out of the computer base.

Removing the Display Bezel

⚠ CAUTION: Before working inside your computer, follow the safety instructions in the *Product Information Guide*.

⚠ CAUTION: To prevent static damage to components inside your computer, discharge static electricity from your body before you touch any of your computer's electronic components. You can do so by touching an unpainted metal surface.

1. Follow the instructions in [Before You Begin](#).
2. Remove the display assembly (see [Display Assembly](#)).

3. Use a plastic scribe to pry the six rubber screw covers/display bumpers out of the screw holes on the front of the bezel.

4. Remove the six M2.5 x 5-mm shoulder screws from the front of the bezel.

🔗 **NOTICE:** Carefully separate the bezel from the display back cover to avoid damage to the bezel.

5. Starting from the inside edges of the bezel, use your fingers to gently pry the bezel upward and outward from the display panel.



1	screw covers/display bumpers (6)	2	M2.5 x 5-mm shoulder screws (6)	3	display bezel
4	display panel	5	display back cover		

🔗 **NOTICE:** To avoid damaging the computer when replacing the display bezel, ensure that the bezel edges line up with those on the display back cover, and snap into place around the entire perimeter of the display back cover.

Removing the Display Panel

⚠️ **CAUTION:** Before working inside your computer, follow the safety instructions in the *Product Information Guide*.

⚠️ **CAUTION:** To prevent static damage to components inside your computer, discharge static electricity from your body before you touch any of your computer's electronic components. You can do so by touching an unpainted metal surface.

1. Follow the instructions in [Before You Begin](#).

2. Remove the display assembly (see [Display Assembly](#)).

3. Remove the display bezel (see [Removing the Display Bezel](#)).

4. Remove the three M2 x 3-mm screws from each side of the display panel.

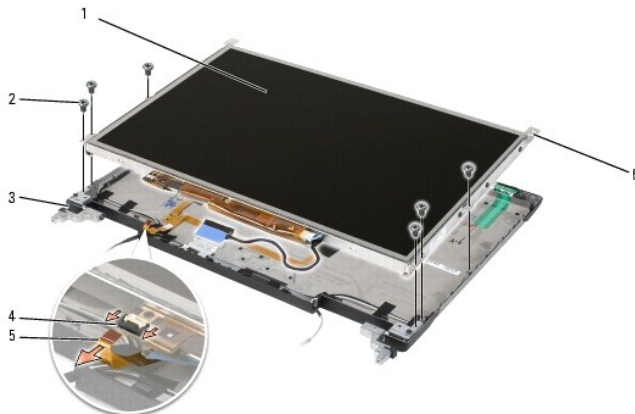

1	display panel	2	M2 x 3-mm screws (6)	3	display back cover
---	---------------	---	----------------------	---	--------------------

4	LED ribbon-cable release tab	5	LED ribbon cable	6	bracket tabs (4)
---	------------------------------	---	------------------	---	------------------

⚠ CAUTION: To avoid damage to your display panel, handle the panel by the bracket tabs only.

- Lift the display panel a few inches from the display back cover.
- Draw the LED ribbon-cable release tab away from the display panel to release the ribbon cable, and lift the display panel fully from the display back cover.

Removing the Display Panel Brackets

⚠ CAUTION: Before working inside your computer, follow the safety instructions in the *Product Information Guide*.

⚠ CAUTION: To prevent static damage to components inside your computer, discharge static electricity from your body before you touch any of your computer's electronic components. You can do so by touching an unpainted metal surface.

- Follow the instructions in [Before You Begin](#).
- Remove the display assembly (see [Display Assembly](#)).
- Remove the display bezel (see [Removing the Display Bezel](#)).
- Remove the display panel (see [Removing the Display Panel](#)).
- Remove the four M2 x 3-mm screws from each side of the display panel.

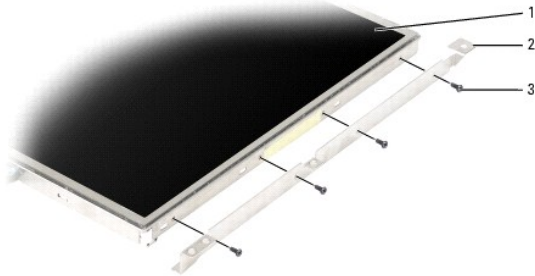

1	display panel	2	display panel brackets (2) (left and right of display panel)	3	M2 x 3-mm screws (4)
---	---------------	---	--	---	----------------------

Removing the Display Panel Cable

⚠ CAUTION: Before working inside your computer, follow the safety instructions in the *Product Information Guide*.

⚠ CAUTION: To prevent static damage to components inside your computer, discharge static electricity from your body before you touch any of your computer's electronic components. You can do so by touching an unpainted metal surface.

- Follow the instructions in [Before You Begin](#).
- Remove the display assembly (see [Display Assembly](#)).
- Remove the display bezel (see [Removing the Display Bezel](#)).
- Remove the display panel (see [Removing the Display Panel](#)).
- Turn over the display panel, placing it on a clean surface.

🔧 NOTICE: To avoid damage to the computer when replacing the bottom flex cable, gently support the bottom of the inverter board with one finger as you reseat the bottom flex-cable connector. Do not bend the inverter board.

6. Gently pull the pull-tab on the bottom flex-cable connector to release the cable from the inverter board.
7. Squeeze the flex-cable release levers at either side of the top flex-cable connector, releasing the connector.

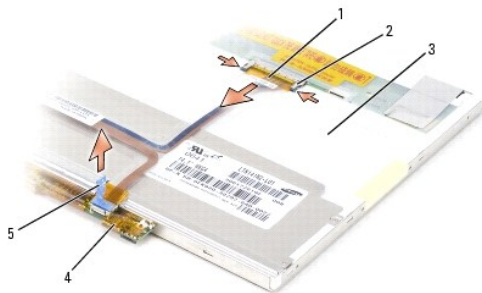

1	top flex-cable connector	2	flex-cable release levers (2)	3	back of display panel
4	inverter board	5	pull-tab on bottom flex-cable connector		

Removing the Display Hinges

CAUTION: Before working inside your computer, follow the safety instructions in the *Product Information Guide*.

CAUTION: To prevent static damage to components inside your computer, discharge static electricity from your body before you touch any of your computer's electronic components. You can do so by touching an unpainted metal surface.

1. Follow the instructions in [Before You Begin](#).
2. Remove the display assembly (see [Display Assembly](#)).
3. Remove the display bezel (see [Removing the Display Bezel](#)).
4. Remove the display Panel (see [Removing the Display Panel](#)).
5. Remove the M2.5 x 5-mm screw from the right display hinge.
6. Lift the right display hinge off the two alignment pins and out of the display back cover.
7. Repeat [step 5](#) and [step 6](#) for the left display hinge.

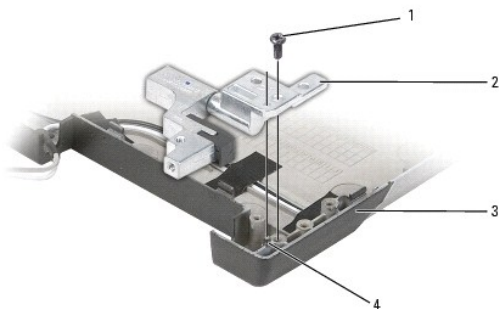

1	M2.5 x 5-mm screw	2	display hinges (2) (left and right)	3	display back cover
4	alignment pin				

Fan

Dell™ Latitude™ ATG D620 Service Manual

- ⚠ CAUTION:** Before working inside your computer, follow the safety instructions in the *Product Information Guide*.
- ⚠ CAUTION:** To prevent static damage to components inside your computer, discharge static electricity from your body before you touch any of your computer's electronic components. You can do so by touching an unpainted metal surface.

1. Follow the instructions in [Before You Begin](#).
2. Remove the system board (see [System Board](#)).
3. Remove the M2.5 x 5-mm screw that secures the fan to the base.

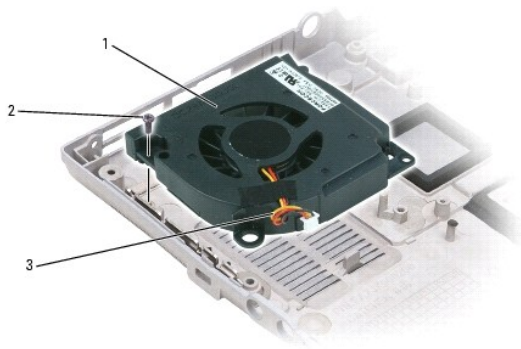







1	fan assembly	1	M2.5 x 5-mm screw	3	fan power cable
---	--------------	---	-------------------	---	-----------------

4. Lift the fan assembly out of the base.

Hard Drive

Dell™ Latitude™ ATG D620 Service Manual



-  **CAUTION:** If you remove the hard drive from the computer when the drive is hot, *do not touch* the metal housing of the hard drive.
-  **CAUTION:** Before working inside your computer, follow the safety instructions in the *Product Information Guide*.
-  **NOTICE:** To prevent data loss, turn off your computer before removing the hard drive. Do not remove the hard drive while the computer is on, in standby mode, or in hibernate mode.
-  **NOTICE:** Hard drives are extremely fragile; even a slight bump can damage the drive.
-  **NOTE:** Dell does not guarantee compatibility or provide support for hard drives from sources other than Dell.
-  **NOTE:** You need the *Operating System* CD to install the Microsoft® Windows® operating system. You also need the *Drivers and Utilities* CD for your computer to install the drivers and utilities on the new hard drive.

To replace the hard drive in the hard drive bay:

1. Follow the procedures in [Before You Begin](#).



1	screws (2)	2	hard drive
---	------------	---	------------

2. Turn the computer over, and remove the two hard drive screws.
-  **NOTICE:** When the hard drive is not in the computer, store it in protective antistatic packaging. See "Protecting Against Electrostatic Discharge" in the *Product Information Guide*.
3. Slide the hard drive out of the computer.
 4. Remove the new drive from its packaging.
Save the original packaging for storing or shipping the hard drive.
-  **NOTICE:** Use firm and even pressure to slide the drive into place. If you use excessive force, you may damage the connector.
5. Slide the hard drive into the bay until it is fully seated.
 6. Replace and tighten the two screws.
 7. Use the *Operating System* CD to install the operating system for your computer (see your *User's Guide* for information).
 8. Use the *Drivers and Utilities* CD to install the drivers and utilities for your computer (see your *User's Guide* for information).

Hinge Cover

Dell™ Latitude™ ATG D620 Service Manual

⚠ CAUTION: Before working inside your computer, follow the safety instructions in the *Product Information Guide*.

➡ NOTICE: To avoid electrostatic discharge, ground yourself by using a wrist grounding strap or by periodically touching an unpainted metal surface (such as a connector on the back of the computer).

➡ NOTICE: The hinge cover is fragile and can be damaged if extreme force is used. Be careful when removing the hinge cover.

1. Follow the procedures in [Before You Begin](#).

2. Turn the computer top-side up, and then open the display all the way (180 degrees) so that the display rests on your work surface.

➡ NOTICE: To avoid damaging the hinge cover, do not lift the cover on both sides simultaneously. Removing the hinge cover in a different way than described may cause the plastic to break.



1	hinge cover	2	plastic scribe	3	indent
---	-------------	---	----------------	---	--------

3. Starting on the right side of the computer, use a plastic scribe (inserted into the indent) to pry up the hinge cover. Lift the cover away from the computer going from the right toward the left, and lay the cover aside.

Before installing the hinge cover, ensure that all cables are routed correctly. Improper routing of the cables can cause damage to the cables.

4. To replace the hinge cover, insert the left edge of the cover into place.

5. Press from left to right until the cover snaps into place, ensuring that the hinge cover edges line up with those on the palm rest.

Keyboard

Dell™ Latitude™ ATG D620 Service Manual

- [Removing the Keyboard](#)
- [Replacing the Keyboard](#)

Removing the Keyboard

- ⚠ **CAUTION:** Before working inside your computer, follow the safety instructions in the *Product Information Guide*.
- ⚠ **CAUTION:** To prevent static damage to components inside your computer, discharge static electricity from your body before you touch any of your computer's electronic components. You can do so by touching an unpainted metal surface.

1. Follow the instructions in [Before You Begin](#).
2. Turn the computer right-side up and open it.
3. Remove the hinge cover (see [Hinge Cover](#)).

➡ **NOTICE:** The keycaps on the keyboard are fragile, easily dislodged, and time-consuming to replace. Be careful when removing and handling the keyboard.

4. Remove the three screws at the top of the keyboard.



1	screws (3)	2	keyboard tabs (5)	3	palm rest
4	pull-tab	5	keyboard-cable locking arm	6	keyboard cable connector

🔧 **NOTE:** Lift the keyboard carefully in [step 5](#) to ensure that you do not pull on the keyboard cable.

5. Easing the edges of the keyboard out of the small detents on the sides, rotate the keyboard up 90- degrees and lay it on the palm rest to gain access to the keyboard connector.
6. If the keyboard cable is held in place by a locking arm next to the keyboard connector, carefully spread the retaining bracket away from the connector so that you can pivot the locking arm upward to release the cable.
7. Pull up on the pull-tab to disconnect the keyboard cable connector from the keyboard connector on the system board.

Replacing the Keyboard

➡ **NOTICE:** To avoid scratching the palm rest when replacing the keyboard, hook the tabs along the front edge of the keyboard into the palm rest, and then secure the keyboard in place.

1. Connect the keyboard connector to the system board.

2. Fold the pull-tab down and secure it and the keyboard cable underneath the locking arm before locking it in place.
 3. Place the tabs along the front edge of the keyboard into the palm rest and lay the keyboard down on the palm rest, pressing the sides down into the detents.
 4. Replace the three screws at the top of the keyboard.
 5. Replace the hinge cover (see [Hinge Cover](#)).
-

[Back to Contents Page](#)

Memory

Dell™ Latitude™ ATG D620 Service Manual

- [DIMM A](#)
- [DIMM B](#)

- ⚠ CAUTION:** Before you begin any of the procedures in this section, follow the safety instructions in the *Product Information Guide*.
- ➡ NOTICE:** If your computer has only one memory module, install the memory module in the connector labeled "DIMM A," which is underneath the keyboard.
- ➡ NOTICE:** If you remove your original memory modules from the computer during a memory upgrade, keep them separate from any new modules that you may have, even if you purchased the new modules from Dell. If possible, *do not* pair an original memory module with a new memory module. Otherwise, your computer may not function at optimal performance.
- 🔧 NOTE:** Memory modules purchased from Dell are covered under your computer warranty.

Your computer has two user-accessible SODIMM sockets, one accessed from beneath the keyboard (DIMM A), and the other accessed from the bottom of the computer (DIMM B).

DIMM A

1. Follow the procedures in [Before You Begin](#).
2. Remove the hinge cover (see [Hinge Cover](#)).
3. Remove the keyboard (see [Keyboard](#)).

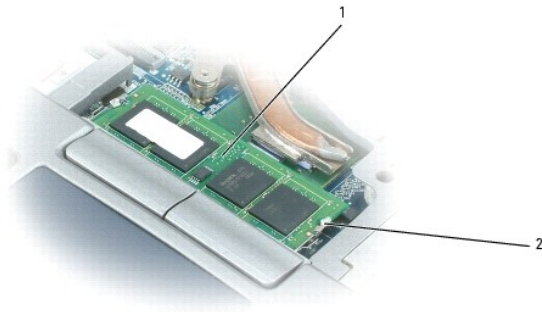

1	memory module (DIMM A)	2	securing clips (2)
---	------------------------	---	--------------------

- ➡ NOTICE:** To prevent damage to the memory module connector, do not use tools to spread the memory-module securing clips.
4. If you are replacing a memory module, ground yourself and remove the existing module:
 - a. Use your fingertips to carefully spread apart the securing clips on each end of the memory module connector until the module pops up.
 - b. Remove the module from the connector.

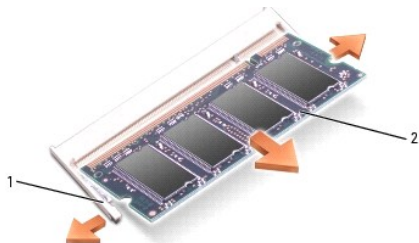

1	securing clips (2 per connector)	2	memory module
---	----------------------------------	---	---------------

5. Ground yourself and install the new memory module:
 - a. Align the notch in the module connector with the tab in the connector slot.
 - b. Slide the module firmly into the slot at a 45-degree angle, and rotate the module down until it clicks into place. If you do not feel the click, remove the module and reinstall it.

 **NOTE:** If the memory module is not installed properly, the computer may not boot properly. No error message indicates this failure.

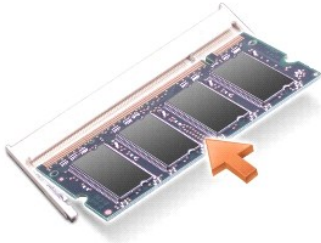

DIMM B

 **NOTE:** If you need to install memory modules in two connectors, install a memory module in the connector labeled "DIMM A" before you install a module in the connector labeled "DIMM B." Insert memory modules at a 45-degree angle to avoid damaging the connector.

1. Follow the procedures in [Before You Begin](#).
2. Turn the computer bottom-side up, loosen the captive screw in the memory module cover, and then remove the cover.

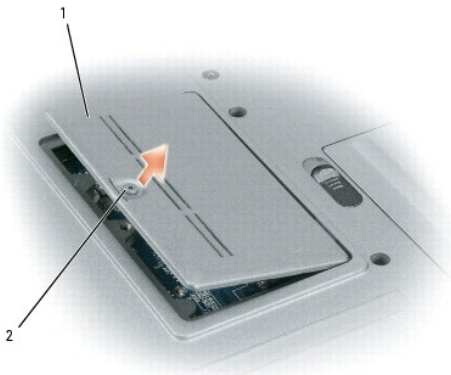

1	memory module cover	2	captive screw
---	---------------------	---	---------------

 **NOTE:** To prevent damage to the memory module connector, do not use tools to spread the memory-module securing clips.

3. If you are replacing a memory module, ground yourself and remove the existing module:
 - a. Use your fingertips to carefully spread apart the securing clips on each end of the memory module connector until the module pops up.
 - b. Remove the module from the connector.

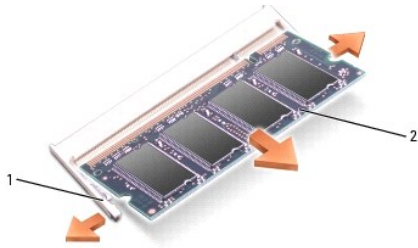

1	securing clips (2 per connector)	2	memory module
---	----------------------------------	---	---------------

➡ **NOTICE:** Insert memory modules at a 45-degree angle to avoid damaging the connector.

4. Ground yourself and install the new memory module:

- Align the notch in the module edge connector with the tab in the connector slot.
- Slide the module firmly into the slot at a 45-degree angle, and rotate the module down until it clicks into place. If you do not feel the click, remove the module and reinstall it.

🔧 **NOTE:** If the memory module is not installed properly, the computer may not boot properly. No error message indicates this failure.

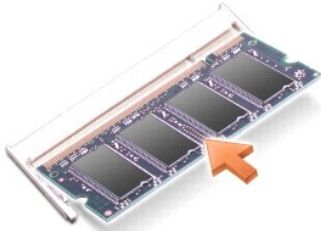

5. Replace the memory module cover.

➡ **NOTICE:** If the cover is difficult to close, remove the module and reinstall it. Forcing the cover to close may damage your computer.

6. Insert the battery into the battery bay, or connect the AC adapter to your computer and an electrical outlet.

7. Turn on the computer.

As the computer boots, it detects the additional memory and automatically updates the system configuration information.

To confirm the amount of memory installed in the computer, click **Start**→ **Help and Support**→ **Use Tools to view your computer information and diagnose problems**→ **My Computer Information**.

Communications Cards

Dell™ Latitude™ ATG D620 Service Manual

- [Wireless Local Area Network \(WLAN\) Card](#)
- [Mobile Broadband Network \(WWAN\) Card](#)
- [Subscriber Identity Module \(SIM\) Card](#)

Wireless Local Area Network (WLAN) Card

If you ordered a WLAN card with your computer, the card is already installed.

⚠ CAUTION: Before you begin any of the procedures in this section, follow the safety instructions in the *Product Information Guide*.

1. Follow the procedures in [Before You Begin](#).
2. Remove the hinge cover (see [Hinge Cover](#)).
3. Remove the keyboard (see [Keyboard](#)).



1	WLAN card	2	antenna cable connectors (2)
---	-----------	---	------------------------------

➡ **NOTICE:** To prevent damage to the connector, do not use tools to release the securing tabs.

4. If a WLAN card is not already installed, go to [step 5](#). If you are replacing a WLAN card, remove the existing card:
 - a. Disconnect the antenna cables from the card.

🔧 NOTE: The WLAN card may have two or three antenna connectors, depending on the type of card you have.

- b. Release the card by pushing the metal securing tabs away from the card until the card pops up slightly.
- c. Slide the card at a 45-degree angle out of its connector.

➡ **NOTICE:** The card connector is keyed to ensure correct insertion. If you feel resistance, check the connector and realign the card.

➡ **NOTICE:** Do not insert a Mobile Broadband network (WWAN) card into the WLAN card connector.

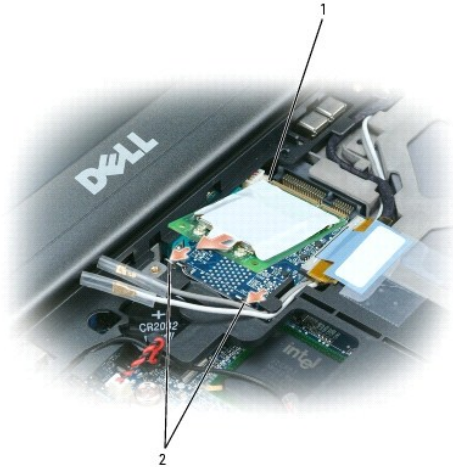

1	WLAN card	2	metal securing tabs (2)
---	-----------	---	-------------------------

➔ **NOTICE:** To avoid damaging the WLAN card, never place cables on top of or under the card.

5. To install a WLAN card:
 - a. Move any antenna cables out of the way to make space for the WLAN card.
 - b. Insert the WLAN card into the system board connector at a 45-degree angle, and press the card into the metal securing tabs until you feel a click.



1	WLAN card	2	system board connector	3	antenna cable connectors
---	-----------	---	------------------------	---	--------------------------

🔍 **NOTE:** For more specific information about which cable to connect to which connector, see the documentation that came with your WLAN card.

- c. Connect the antenna cables to the WLAN card, ensuring that you route the cables correctly.

Mobile Broadband Network (WWAN) Card

🔍 **NOTE:** Mobile Broadband network cards may not be available in certain regions.

If you ordered a Mobile Broadband network card with your computer, the card is already installed.

⚠️ **CAUTION:** Before you begin any of the procedures in this section, follow the safety instructions in the *Product Information Guide*.

1. Follow the procedures in [Before You Begin](#).
2. Remove the hinge cover (see [Hinge Cover](#)).

3. Remove the keyboard (see [Keyboard](#)).

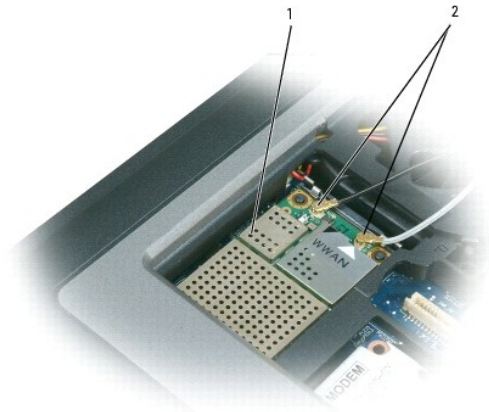

1	Mobile Broadband network card	2	antenna cables (2)
---	-------------------------------	---	--------------------

➡ **NOTICE:** To prevent damage to the connector, do not use tools to release the securing tabs.

4. If a Mobile Broadband network card is not already installed, go to [step 5](#). If you are replacing a Mobile Broadband network card, remove the existing card:
 - a. Disconnect the antenna cables from the Mobile Broadband network card.

🔧 **NOTE:** The Mobile Broadband network card may have two or three antenna connectors, depending on the type of card you have.

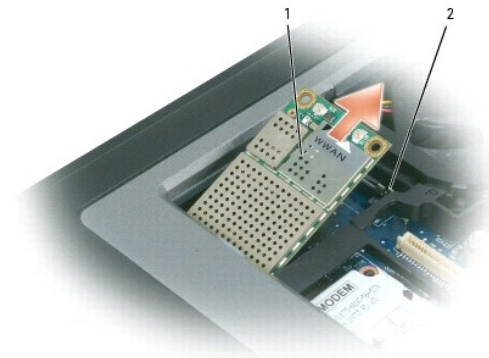

1	Mobile Broadband network card	2	metal securing tabs (2)
---	-------------------------------	---	-------------------------

- b. Release the card by pushing the metal securing tabs away from the card until the card pops up slightly.
- c. Slide the card at a 45-degree angle out of its connector.

➡ **NOTICE:** The connectors are keyed to ensure correct insertion. If you feel resistance, check the connectors and realign the card.

🔧 **NOTE:** Do not insert a WLAN card into the Mobile Broadband network card connector.

5. To install a Mobile Broadband network card:

- a. Move any antenna cables out of the way to make space for the Mobile Broadband network card.

➡ **NOTICE:** To avoid damaging the Mobile Broadband network card, never place cables on top of or under the card and ensure that you route the cables properly.

- b. Insert the card into the system board connector at a 45-degree angle, and press the card into the metal securing tabs until you feel a click.

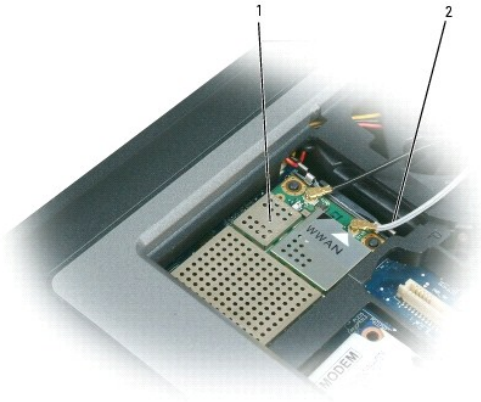

1	Mobile Broadband network card	2	antenna cables (2)
---	-------------------------------	---	--------------------

NOTE: For more specific information about which cable to connect to which connector, see the documentation that came with your Mobile Broadband network card.

6. Connect the antenna cables to the Mobile Broadband network card, ensuring that you route the cables correctly.

Subscriber Identity Module (SIM) Card

CAUTION: Before you begin any of the procedures in this section, follow the safety instructions in the *Product Information Guide*.

1. Follow the procedures in [Before You Begin](#).

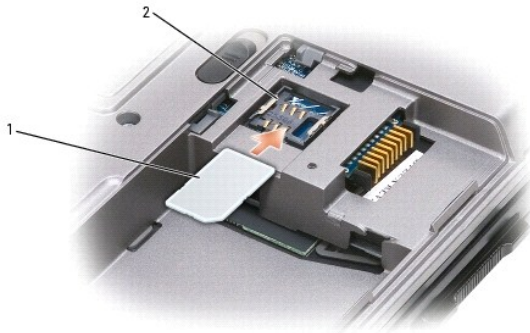

1	SIM card	2	metal brackets (2)
---	----------	---	--------------------

NOTICE: Do not touch the SIM card connectors to protect the card from electrostatic discharge (ESD). To prevent ESD, hold the card in your hand before you insert or remove the card.

2. Turn the computer upside-down with the front of the computer facing you.
3. Ensure that the battery is removed (see [Before Working Inside Your Computer](#)).
4. With the cut-off corner on the card facing away from the card compartment, insert the SIM card into the compartment (as shown) so that it slides under the metal bracket on the sides.

[Back to Contents Page](#)

Modem

Dell™ Latitude™ ATG D620 Service Manual

⚠ CAUTION: Before you begin the following procedure, see the safety instructions in the *Product Information Guide*.

⚠ CAUTION: To prevent static damage to components inside your computer, discharge static electricity from your body before you touch any of your computer's electronic components. You can do so by touching an unpainted metal surface.

👉 NOTICE: To avoid damaging the system board, you must remove the main battery before you begin working inside the computer (see [Before Working Inside Your Computer](#)).

1. Follow the instructions in [Before You Begin](#).
2. Remove the hinge cover (see [Hinge Cover](#)).
3. Remove any installed media bay device (see [Media Bay Devices](#)).
4. Remove the keyboard (see [Keyboard](#)).
5. Remove the display assembly (see [Display Assembly](#)).
6. Remove the palm rest (see [Palm Rest](#)).
7. Remove the M2 x 3-mm screw that attaches the modem to the system board.
8. Pull up on the pull-tab to disconnect the modem from the connector on the system board.

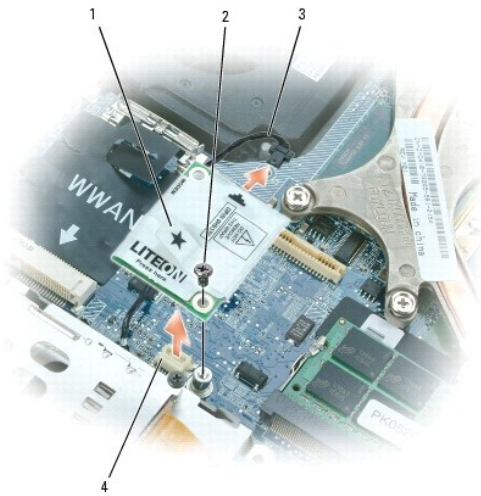

1	modem pull-tab	2	M2 x 3-mm screw	3	modem cable
4	system board connector				

👉 NOTICE: Do not disconnect the modem cable from the system board.

9. Disconnect the modem cable from the modem.

When replacing the modem, it is easier to connect the modem cable to the modem *before* you press the modem into the system board connector.

[Back to Contents Page](#)

Media Bay Devices

Dell™ Latitude™ ATG D620 Service Manual

🔔 **NOTICE:** To prevent damage to devices, store them in a safe, dry place when they are not installed in the computer. Avoid pressing down on them or placing heavy objects on top of them.

🔧 **NOTE:** If the device security screw is not present, you can remove and install devices while the computer is running and connected to a docking device (docked).

1. If present, remove the device security screw from the bottom of the computer.



2. If the computer is running, double-click the **Safely Remove Hardware** icon on the taskbar, click the device you want to eject, and click **Stop**.
3. Press the device latch release.



1	optical drive	2	device latch release
---	---------------	---	----------------------

4. Pull the device out of the media bay.

To install a device, push the new device into the bay until it clicks into place.

[Back to Contents Page](#)

[Back to Contents Page](#)

Palm Rest

Dell™ Latitude™ ATG D620 Service Manual

⚠ CAUTION: Before working inside your computer, follow the safety instructions in the *Product Information Guide*.

⚠ CAUTION: To prevent static damage to components inside your computer, discharge static electricity from your body before you touch any of your computer's electronic components. You can do so by touching an unpainted metal surface.

1. Follow the instructions in [Before You Begin](#).
2. Remove the hinge cover (see [Hinge Cover](#)).
3. Remove any installed media bay device (see [Media Bay Devices](#)).
4. Remove the keyboard (see [Keyboard](#)).
5. Remove the display assembly (see [Display Assembly](#)).
6. Disconnect the coin-cell battery from the system board (see [Coin-Cell Battery](#)).

🔧 NOTE: You can leave the coin-cell battery in place (on the palm rest) unless you are installing a replacement palm rest, in which case you need to remove the coin-cell battery and place it in the replacement palm rest.

7. Remove the three M2.5 x 8-mm screws labeled "P" from the top of the palm rest.

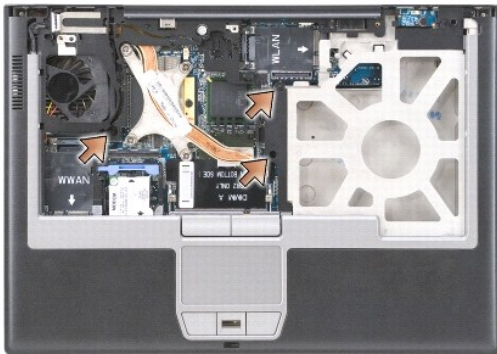

8. Turn the computer upside-down.
9. Remove the hard drive (see [Hard Drive](#)).
10. Loosen the two captive screws located at the front of the hard drive bay.

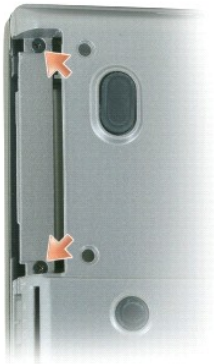

11. Remove the seven M2.5 x 8-mm screws from the bottom of the computer.



NOTICE: Carefully separate the palm rest from the base to avoid damage to the palm rest.

12. Turn the computer top-side up and remove the palm rest.

- a. Starting at the back center of the palm rest, use your fingers to separate the palm rest from the base by lifting the inside edge of the palm rest.
- b. After the back of the palm rest is unsnapped, push the palm rest slightly forward to unhook the remainder of the palm rest from the front of the base.

13. Disconnect the touch-pad cable connector from the system board.





1	touch pad connector
---	---------------------

NOTICE: When reinstalling the palm rest, ensure that you reconnect the touch pad cable connector to the system board before replacing the palm rest screws.

[Back to Contents Page](#)

PC Card Reader

Dell™ Latitude™ ATG D620 Service Manual

-  **CAUTION:** Before working inside your computer, follow the safety instructions in the *Product Information Guide*.
-  **CAUTION:** To prevent static damage to components inside your computer, discharge static electricity from your body before you touch any of your computer's electronic components. You can do so by touching an unpainted metal surface.

1. Follow the instructions in [Before Working Inside Your Computer](#).
2. Remove the hinge cover (see [Hinge Cover](#)).
3. Remove any installed media bay device (see [Media Bay Devices](#)).
4. Remove the keyboard (see [Keyboard](#)).
5. Remove the palm rest (see [Palm Rest](#)).
6. Remove the four M2 x 3-mm screws that secure the PC Card reader to the computer.

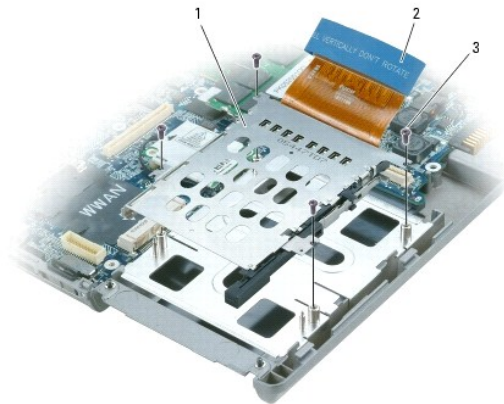

1	PC Card reader	2	pull-tab	3	M2 x 3-mm screws (4)
---	----------------	---	----------	---	----------------------

-  **NOTICE:** To avoid damaging the PC Card reader connector, do not rotate or rock the connector as you remove it. Use firm and even pressure to lift the pull-tab vertically.

7. Use the pull-tab to disconnect the PC Card reader connector from the system board.

Speaker

Dell™ Latitude™ ATG D620 Service Manual

- ⚠ CAUTION:** Before working inside your computer, follow the safety instructions in the *Product Information Guide*.
- ⚠ CAUTION:** To prevent static damage to components inside your computer, discharge static electricity from your body before you touch any of your computer's electronic components. You can do so by touching an unpainted metal surface.

1. Follow the instructions in [Before Working Inside Your Computer](#).
2. Remove the hinge cover (see [Hinge Cover](#)).
3. Remove any installed media bay device (see [Media Bay Devices](#)).
4. Remove the keyboard (see [Keyboard](#)).
5. Remove the coin-cell battery (see [Coin-Cell Battery](#)).
6. Remove the palm rest (see [Palm Rest](#)).
7. Disconnect the speaker connector from the system board.



1	speaker connector
---	-------------------

- 👉 NOTICE:** Handle the speakers with care to avoid damaging them.

8. Pull the speaker straight up and out of the base.

System Board

Dell™ Latitude™ ATG D620 Service Manual

- [Removing the System Board](#)
- [Installing the System Board](#)

Removing the System Board

⚠ CAUTION: Before working inside your computer, follow the safety instructions in the *Product Information Guide*.

⚠ CAUTION: To prevent static damage to components inside your computer, discharge static electricity from your body before you touch any of your computer's electronic components. You can do so by touching an unpainted metal surface.

The system board's BIOS chip contains the Service Tag, which is also visible on a barcode label on the bottom of the computer. The replacement kit for the system board includes a CD that provides a utility for transferring the Service Tag to the replacement system board.

1. Follow the instructions in [Before Working Inside Your Computer](#).
2. Remove the hinge cover (see [Hinge Cover](#)).
3. Remove the keyboard (see [Keyboard](#)).
4. Remove any installed media bay device (see [Media Bay Devices](#)).
5. Remove the memory module(s) (see [Memory](#)).
6. Remove any installed wireless communications cards (see [Communications Cards](#)).
7. Remove the palm rest (see [Palm Rest](#)).
8. Remove the modem (see [Modem](#)).
9. Remove the speaker (see [Speaker](#)).
10. Remove the PC Card reader (see [PC Card Reader](#)).
11. Remove any installed smart cards or smart card blanks from the smart card slot.



12. Remove the processor thermal-cooling assembly (see [Processor Thermal-Cooling Assembly](#)).
13. Remove the processor (see [Processor](#)).
14. Disconnect the fan cable from the system board.
15. Disconnect the cables near the WLAN card and the modem connector from the system board.
16. Remove the four M2.5 x 5-mm screws (labeled with silver triangles on the system board).



1	fan cable	2	M2.5 x 5-mm screws (4) (identified by silver triangles on the system board)	3	modem antenna connectors (2)
---	-----------	---	---	---	------------------------------

17. Remove the four 5-mm hex screws on the back of the computer.



18. Lift the system board out and away from the base.

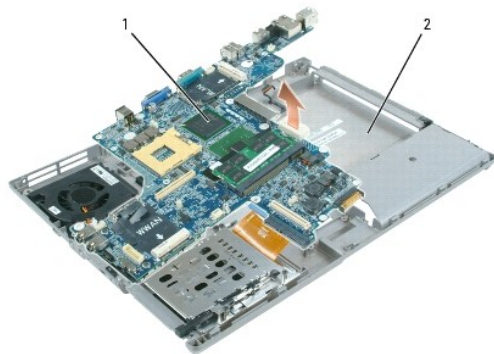

1	system board	2	base
---	--------------	---	------

Installing the System Board

1. Perform all the steps in [Removing the System Board](#) in reverse order.

NOTICE: When installing the system board, ensure that the fan cable and antenna cables are clear of the system board before fitting it into the base, that the audio connectors are properly seated, and that the tab for the wireless switch fits properly into the detent on the slider mechanism before installing the system board into the base.

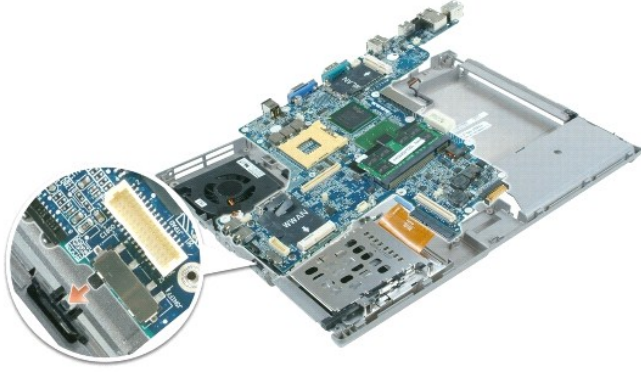

2. Insert the battery into the battery bay (see [Before Working Inside Your Computer](#)).
3. Connect the AC adapter to the computer and to an electrical outlet.

🔔 **NOTICE:** Before turning on the computer, replace all screws and ensure that no stray screws remain inside the computer. Failure to do so may result in damage to the computer.

4. Turn on the computer.

🔧 **NOTE:** After replacing the system board, use the CD that accompanied the replacement system board to enter the computer Service Tag into the BIOS.

5. Insert the CD that accompanied the replacement system board into the appropriate drive and flash the system BIOS (see [Flashing the BIOS](#)). Follow the instructions on the screen.

[Back to Contents Page](#)

Processor Thermal-Cooling Assembly

Dell™ Latitude™ ATG D620 Service Manual

- [Removing the Processor Thermal-Cooling Assembly](#)
- [Replacing the Processor Thermal-Cooling Assembly](#)

Removing the Processor Thermal-Cooling Assembly

- ⚠ **CAUTION:** Before working inside your computer, follow the safety instructions in the *Product Information Guide*.
- ⚠ **CAUTION:** To prevent static damage to components inside your computer, discharge static electricity from your body before you touch any of your computer's electronic components. You can do so by touching an unpainted metal surface.

1. Follow the instructions in [Before Working Inside Your Computer](#).
2. Remove the hinge cover (see [Hinge Cover](#)).
3. Remove any installed media bay device (see [Media Bay Devices](#)).
4. Remove the keyboard (see [Keyboard](#)).
5. Remove the palm rest (see [Palm Rest](#)).

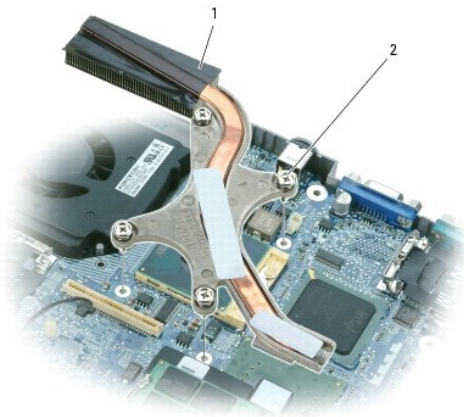

1	processor thermal-cooling assembly	2	captive screws (4)		
---	------------------------------------	---	--------------------	--	--

🔍 **NOTE:** The processor thermal-cooling assembly may differ in appearance, depending on your computer configuration. However, the removal procedure is the same for all assemblies.

6. Loosen in consecutive order the four captive screws, labeled "1" through "4," on the assembly.
7. Lift the assembly out of the computer.

Replacing the Processor Thermal-Cooling Assembly

- ⚠ **CAUTION:** Before working inside your computer, follow the safety instructions in the *Product Information Guide*.
- 🔄 **NOTICE:** To prevent static damage to components inside your computer, discharge static electricity from your body before you touch any of your computer's electronic components. You can do so by touching an unpainted metal surface.
- 🔍 **NOTE:** The original pad can be reused if the original processor and heat sink are reinstalled together. If either the processor or heat sink is replaced, use the thermal pad provided in the kit to ensure that thermal conductivity is achieved.
- 🔍 **NOTE:** This procedure assumes that you have already removed the processor thermal-cooling assembly and are ready to replace it.

1. Peel the backing off the thermal cooling pad and adhere the pad to the portion of the thermal-cooling assembly that covers the processor.
2. Place the assembly on the system board.
3. Tighten in consecutive order the four captive screws, labeled "1" through "4," on the thermal-cooling assembly.
4. Replace the palm rest (see [Palm Rest](#)).

 **NOTE:** Ensure that you reconnect the coin-cell battery (see [Coin-Cell Battery](#)) before you replace the keyboard.

5. Replace the keyboard (see [Keyboard](#)).
6. Replace the media bay device (see [Media Bay Devices](#)).
7. Replace the hinge cover (see [Hinge Cover](#)).
8. Replace the battery.

[Back to Contents Page](#)

[Back to Contents Page](#)

Dell™ Latitude™ ATG D620 Service Manual



NOTE: A NOTE indicates important information that helps you make better use of your computer.



NOTICE: A NOTICE indicates either potential damage to hardware or loss of data and tells you how to avoid the problem.



CAUTION: A CAUTION indicates a potential for property damage, personal injury, or death.

Information in this document is subject to change without notice.
© 2007 Dell Inc. All rights reserved.

Reproduction in any manner whatsoever without the written permission of Dell Inc. is strictly forbidden.

Trademarks used in this text: *Dell*, the *DELL* logo, and *Latitude* are trademarks of Dell Inc.; *Microsoft* and *Windows* are registered trademarks of Microsoft Corporation; *Bluetooth* is a registered trademark owned by Bluetooth SIG, Inc. and is used by Dell under license.

Other trademarks and trade names may be used in this document to refer to either the entities claiming the marks and names or their products. Dell Inc. disclaims any proprietary interest in trademarks and trade names other than its own.

January 2007 Rev. A00

[Back to Contents Page](#)